

**10 008 0370**



**KIT CILINDRO - CYLINDER KIT**

**PIAGGIO 150:** Vespa Px 57,8 mm - Cosa (R.O. 244172)



**10 060 9470**



**FILTRO OLIO - OIL FILTER**  
**LML 125: 4t**



**10 068 9670**



**SERIE GUARNIZIONI**  
**GASKET TOP SET**  
Motore AM6 50 cc.

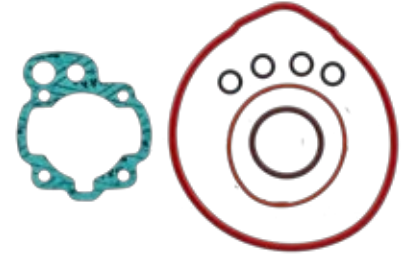

**12 183 0050**



**GOMMINO CAVALLETTO CENTRALE**  
**CENTRAL STAND RUBBER**

**KYMCO 50:** Agility 4T R12 07-08 • 4T R16 09 • Rs 09 • Rs Naked 2T 10 • Dink 4T 07 • Like 2-4T 09 • People S 4T 06-08 • Sento 08 • Super 8 07  
**125:** Dink Eu 3 06-07 • Downtown 09 • People S 05 • People S Dd Eu 3 07-08 • **150:** Agility R16 08  
**200:** Agility I R16 10 • Dink Eu 3 I 06-07 • People S 05 • People S I 07 • Like I 09 • **250:** People S 06 • S I 07 • X Citing 05 • I 06-07  
**300:** Downtown I 09 • Abs 10 • People S I 08 • X Citing I 08 • I R 08 • I R 09 • **500:** X Citing R 09 • X Citing 05 • I 06-08 • R 07-08



**16 359 2460**



**TRASMISSIONE COMANDO GAS - SUPERIORE**  
**UPPER THROTTLE TRANSMISSION**  
**YAMAHA:** Bw's Aerox 08/11 (R.O. 3VLF63110200)



**16 359 7320**



**TRASMISSIONE GAS INFERIORE**  
**LOWER THROTTLE TRANSMISSION**  
**YAMAHA:** Bw's Naked 04/11 (R.O. 5WWF63120000)



**24 635 0040**



**ARTICOLO RIPRISTINATO**

Statore 6 poli Ø 117mm  
Stator 6 poles Ø 117 mm  
**50:** Free FL • Delivery 95-02 • Liberty 97-05 • Nrg 94-96 • Nrg Extreme 99-10 • Nrg Mc3 01-04 • Nrg Rst Mc2 96-98 • Ntt 95-96 • Quartz 99-96 • Sfera • Rst 91-97 • Zip 92-96 • SP/Rst 96-00 • Zip Fast Raider Rst 96-97 (R.O. 830294)



**12 165 0042**



**TAPPO SERBATOIO - TANK CAP**  
**PIAGGIO 50:** Vespa FL - N - Pk  
**125-150-200:** Vespa Px - T5 (R.O. 575825)



**10 011 0350**



**KIT REVISIONE POMPA ACQUA**  
**WATER PUMP SETS**  
**YAMAHA 125:** X City - X Max



**12 161 0352**



**CAVALLETTO CENTRALE - CENTRAL STAND**  
**PIAGGIO 50-90 -125:** Vespa primavera • Et3  
Cromato/ Chromed



**12 161 0372**



**CAVALLETTO CENTRALE - CENTRAL STAND**  
**125-150-200:** Vespa Px  
Cromato/ Chromed



**12 161 0672**



**CAVALLETTO CENTRALE - CENTRAL STAND**  
**PIAGGIO 50-125:** Vespa Pk  
Cromato/ Chromed



**12 161 0682**



**CAVALLETTO CENTRALE - CENTRAL STAND**  
**PIAGGIO 150:** Vespa GL • Sprint  
**200:** Rally  
Cromato/ Chromed



**12 161 0790**



**CAVALLETTO CENTRALE - CENTRAL STAND**  
**PIAGGIO 125:** Vespa T5  
Nero/ Black  
(R.O. 232904)



**12 161 0820**



**CAVALLETTO CENTRALE - CENTRAL STAND**  
**KYMCO 125-200:** People  
(R.O. 0016704)



**12 161 0800**



**CAVALLETTO CENTRALE - CENTRAL STAND**  
**PIAGGIO 125 1958 - 150 1959**  
Zincato/ Galvanizad  
Senza gommini - Without Rubber Pads  
(R.O.54151)

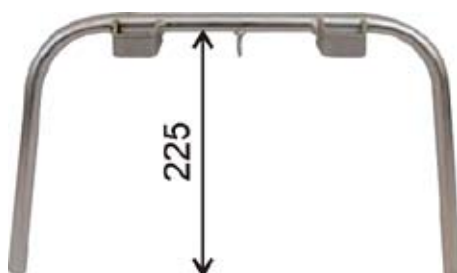

**12 161 0810**



**CAVALLETTO CENTRALE - CENTRAL STAND**  
**PIAGGIO 150 GL 61-63**  
Zincato/ Galvanizad  
Senza gommini - Without Rubber Pads  
(R.O. 54140)

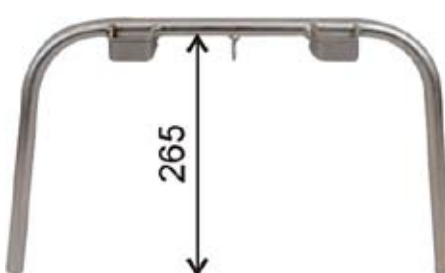

**12 161 9210**



**COPPIA PIASTRINE CAVALLETTO CENTRALE**  
**CENTRAL STAND BRACKET**  
**PIAGGIO 150:** Vespa GL Sprint  
(R.O. 59188/9)



**12 157 0050**



**FORCELLA - FORK**  
**PIAGGIO 50:** Vespa Pk FL2  
(R.O. 266303)



**12 157 0110**



**FORCELLA - FORK**  
**PIAGGIO 50:** Vespa Pk - Automatica - Plurimatic  
(R.O. 244830)



**12 157 0130**



**FORCELLA - FORK**  
**PIAGGIO 125:** Vespa T5  
(R.O. 232923)



**12 157 0140**



**FORCELLA - FORK**  
**PIAGGIO 125-150-200:** Cosa 1-2  
(R.O. 229733)



**12 157 0160**



**FORCELLA - FORK**  
**PIAGGIO 150:** Vespa Super ruota 8" - Wheel 8"  
(R.O. 152332)



**12 157 0170**



**FORCELLA - FORK**  
**PIAGGIO 150:** Vespa Sprint ruota 10" - Wheel 10"  
(R.O. 152339)



**22 512 0520**



**COPPIA GANASCE FRENO ANTERIORE**  
**FRONT COUPLE BRAKE SHOES**  
**PIAGGIO:** Vespa 150 Sprint Veloce - Vespa 160  
Vespa 180 Ss - Vespa 200 Rally  
(R.O. 026832)

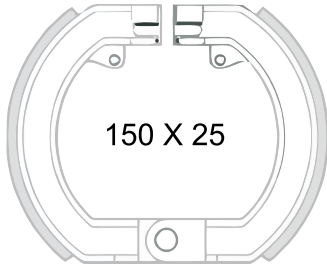

**22 512 0530**



**COPPIA GANASCE FRENO POSTERIORE**  
**REAR COUPLE BRAKE SHOES**  
**PIAGGIO:** Vespa 125-150 51/62  
(R.O. 078170)

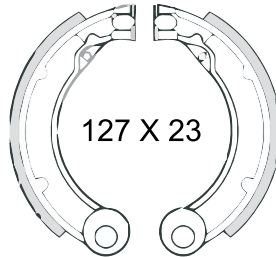

**22 512 0540**



**COPPIA GANASCE FRENO POSTERIORE**  
**REAR COUPLE BRAKE SHOES**  
**PIAGGIO:** Vespa 150 Super  
(R.O. 110412)

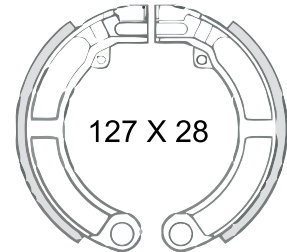

**22 512 0550**



**COPPIA GANASCE FRENO POSTERIORE**  
**REAR COUPLE BRAKE SHOES**  
**PIAGGIO:** Vespa 125-150 Super  
(R.O. 081229)

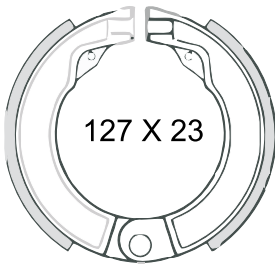

**12 179 0212**



**CILINDRETTO SERRATURA - CYLINDER LOCK**  
**PIAGGIO 50:** Ape 50  
(R.O. 258664)



**12 179 0222**



**LUCCHETTO STERZO**  
**CYLINDER LOCK**  
Chiave in metallo - Metal key  
Guida mm 4 • Size mm 4  
**PIAGGIO 50-125:** Vespa 50 • Primavera - Et3  
Cylinder lock 2 pcs. - 2 keys  
(R.O. 120328)



**12 179 0232**



**CILINDRETTO SERRATURA**  
**CYLINDER LOCKS**  
**PIAGGIO 50-125:** Vespa Pk 50 XL  
Kit 5 pezzi cilindretti - set of 5 pcs.  
(R.O. 196467)



**12 179 0242**



**SBOZZATO CHIAVE - KEY BLANK**  
**PIAGGIO:** Vespa - Ape  
(R.O. 120330)



**12 179 0252**



**SERRATURA BAULETTO - TOOL BOX**  
**PIAGGIO 125-150:** Vespa Px Millenium  
(R.O. 576998)



**24 639 0260**



**MOTORINO AVVIAMENTO**  
**STARTER MOTOR**  
VESPA PX 125-150-200: Cosa 125-200  
(R.O. 249235)



**12 185 6140**



**TAPPO OLIO - OIL CAP**  
**HONDA 150:** Sh  
(5 Pcs/Packing)



**10 060 2600**



**FILTRO ARIA - AIR FILTER**  
**PIAGGIO:** Porter 500  
(R.O: 614945)



**10 060 2620**



**FILTRO ARIA - AIR FILTER**  
**PIAGGIO:** Porter 1300  
(R.O: 1780187Z18000)



**14 266 0220**



**CP. LISTELLI ACCIAIO INOX**  
**COUPLE INOX STRIPES**  
**PIAGGIO:** Vespa Px 125-150-200  
(R.O. 180048)



**26 720 0370**



**STARTER SPRAY**

Applicazione: motore.  
Facilita l'avviamento dei motori diesel e benzina durante la stagione invernale, assicurando sempre una rapida accensione anche a temperature molto basse. Evita il logorio della batteria e ne prolunga la durata.  
Confezione: bombola 200 ml



**26 720 0380**



**NEUTRALITE ACIDO BATTERIE**

Conf. 5 Kg.



**26 720 0390**



**IMPERMEABILIZZANTE**

Applicazione: tessuti, pelle, legno, granito, mattoni, piastrelle, pietra, cotto, cemento. Impermeabilizzante per tutti i materiali porosi. Lunga durata. Grazie all'impiego delle nanotecnologie rispetta la naturale traspirazione del materiale e aderisce straordinariamente alla superficie trattata, senza lasciare zone scoperte che vanificherebbero l'effetto protettivo. Impedisce all'acqua di penetrare in profondità evitando così rigonfiamenti o fessurazioni del legno, l'infiltrazione di acqua in pietre, mattoni, cemento; impermeabilizza i tessuti. Non altera l'aspetto e la mano del substrato

Confezione: flacone pump 200 ml



**26 720 0400**



**🇮🇹 FRENAFILETTI MEDIO**

Frenatura di prigionieri, dadi e bulloni non soggetti a smontaggio. Prodotto a bassa viscosità.

Elimina gli allentamenti dovuti a vibrazioni, urti, sbalzi di temperatura. Impedisce la corrosione ed il grippaggio.

frenatura permanente. Elevata resistenza all'acqua, oli, carburanti, fluidi idraulici e frigoriferi, gas e vapori..

Collaudato secondo le norme din 54454. Temperatura di impiego da -55° c a +150° c. gioco massimo diametrale 0,15 mm. confezione : flacone ml 50

**🇬🇧 THREADLOCKER MEDIUM**

*Tightening of studs, nuts and bolts not subject to removal. Low viscosity product. Avoid loosening due to vibrations, shocks and temperature changes.*

*Prevents corrosion and seizing up. Permanent tightening.*

*High resistance to water, oils, fuels, hydraulic and refrigeration fluids, gas and vapors. tested according to din 54454.*

*operating temperature from -55° c to +150° c. maximum side shake clearance 0,15 mm packaging: 50 ml bottle*



Cc.	Modello - Models	GAS (Comando) Throttle Contr.	GAS (Sdopp. carb.) Doub carb.	GAS (Sdopp. mix) Doub Mixer	STARTER (Comando) Grip	STARTER (Sdopp. carb.) Doub. Carb.	FRENO ANT. Brake Front	FRENO POST. Brake Rear	CONTAKM. Speedom.
50	Trekker 98-00	-	-	-	-	-	-	<b>16 355 5880</b> (736927)	<b>16 363 0800</b> (736721)
50	Trk2 Wrc 04-06	-	-	-	-	-	-	<b>16 355 5880</b> (736927)	<b>16 363 0800</b> (736721)
50	Vivacity 99	<b>16 359 2140</b> (740996)	-	-	-	-	-	<b>16 355 5880</b> (736927)	<b>16 363 0810</b> (739602)
50	Vivacity Catalitico 99-02	<b>16 359 2140</b> (740996)	-	-	-	-	-	<b>16 355 5880</b> (736927)	<b>16 363 0810</b> (739602)
50	Vivacity Vsx-Xr 02-04	<b>16 359 2140</b> (740996)	-	-	-	-	-	<b>16 355 5880</b> (736927)	-
50	X-Fight 00	-	-	-	-	-	-	<b>16 355 5880</b> (736927)	<b>16 363 0770</b> (736610)
50	Xrace 03	-	-	-	-	-	-	-	<b>16 363 0770</b> (736610)
50	Zenith L 94-96	-	-	-	-	-	-	-	<b>16 363 0760</b> (733586)
50	Zenith Ln-Ls 97-98	-	-	-	-	-	-	-	<b>16 363 0760</b> (733586)
100	Elyseo 99-01	-	-	-	-	-	-	<b>16 355 5890</b> (741702)	<b>16 363 0790</b> (740993)
100	Speedfight 97-00	-	-	-	-	-	-	-	<b>16 363 0770</b> (736610)
100	Sv L 98	-	-	-	-	-	-	-	<b>16 363 0730</b> (724335)
100	Trekker 98	-	-	-	-	-	-	<b>16 355 5880</b> (736927)	<b>16 363 0800</b> (736721)
100	Vivacity 99-01	-	-	-	-	-	-	<b>16 355 5880</b> (736927)	<b>16 363 0810</b> (739602)
100	X-Fight 00-01	-	-	-	-	-	-	-	<b>16 363 0770</b> (736610)
125	Sv Geo 91-95	-	-	-	-	-	-	-	<b>16 363 0730</b> (724335)
<b>PIAGGIO</b>									
50	Ciao -	-	-	-	-	-	-	-	<b>16 363 0990</b> (187423)
50	Fly 2T 05-07	<b>16 359 2240</b> (581539)	<b>16 359 7300</b> (583334)	<b>16 359 5030</b> (268403)	-	-	-	<b>16 355 5750</b> (564474)	<b>16 363 1650</b> (600315)
50	Fly 4T 05-08	-	-	-	-	-	-	-	<b>16 363 1650</b> (600315)
50	Fly 4T Mot Chn 06-07	-	-	-	-	-	-	-	<b>16 363 1650</b> (600315)
50	Free 92-94	<b>16 359 2140</b> (581132)	<b>16 359 7120</b> (269064)	<b>16 359 5050</b> (268597)	-	-	-	-	<b>16 363 0950</b> (272352)
50	Free Delivery 00-01	<b>16 359 2140</b> (581132)	<b>16 359 7120</b> (269064)	<b>16 359 5050</b> (268597)	-	-	-	<b>16 355 5300</b> (597383)	<b>16 363 1580</b> (582414)
50	Free FI 95-02	<b>16 359 2140</b> (581132)	<b>16 359 7120</b> (269064)	<b>16 359 5050</b> (268597)	-	-	-	<b>16 355 5300</b> (597383)	<b>16 363 0950</b> (272352)
50	Liberty (Escl. Mo- dello 02) 97-05	<b>16 359 2150</b> (268435)	<b>16 359 7030</b> (581173)	<b>16 359 5080</b> (560448)	-	-	-	<b>16 355 5300</b> (597383)	<b>16 363 0960</b> (560973)
50	Liberty (Modello 02) 97-05	<b>16 359 2150</b> (268435)	<b>16 359 7030</b> (581173)	<b>16 359 5030</b> (268403)	-	-	-	<b>16 355 5300</b> (597383)	<b>16 363 0960</b> (560973)
50	Liberty 2T 06-08	-	<b>16 359 7300</b> (583334)	<b>16 359 5030</b> (268403)	-	-	-	-	-
50	Liberty 2T Rst 04	-	<b>16 359 7300</b> (583334)	<b>16 359 5030</b> (268403)	-	-	-	<b>16 355 5300</b> (597383)	-
50	Liberty 2T Sport 06-08	-	<b>16 359 7300</b> (583334)	<b>16 359 5030</b> (268403)	-	-	-	-	-
50	Liberty 4T 00-02	<b>16 359 2390</b> (582426)	-	-	-	-	-	<b>16 355 5300</b> (597383)	<b>16 363 0960</b> (560973)
50	Liberty 4T Rst 04	<b>16 359 2390</b> (582426)	-	-	-	-	-	<b>16 355 5730</b> (564217)	-
50	Liberty Moc 2T 09	-	<b>16 359 7300</b> (583334)	<b>16 359 5030</b> (268403)	-	-	-	-	-

Vedi pag. 311

Cc.	Modello - Models	GAS (Comando) Throttle Contr.	GAS (Sdopp. carb.) Doub carb.	GAS (Sdopp. mix) Doub Mixer	STARTER (Comando) Grip	STARTER (Sdopp. carb.) Doub. Carb.	FRENO ANT. Brake Front	FRENO POST. Brake Rear	CONTAKM. Speedom.
50	Liberty Ptt Eu2 04-05	-	<b>16 359 7300</b> (583334)	<b>16 359 5030</b> (268403)	-	-	-	<b>16 355 5300</b> (597383)	-
50	Nrg 94-96	<b>16 359 2010</b> (270995)	<b>16 359 7010</b> (272290)	<b>16 359 5010</b> (272290)	-	-	-	<b>16 355 5070</b> (270993)	<b>16 363 0180</b> (563621)
50	Nrg Extreme 99-00	<b>16 359 2240</b> (581539)	<b>16 359 7020</b> (268402)	<b>16 359 5080</b> (560448)	-	-	-	<b>16 355 5690</b> (560711)	<b>16 363 0970</b> (581287)
50	Nrg Extreme (Lc Doppio Disco) 99-00	<b>16 359 2240</b> (581539)	<b>16 359 7020</b> (268402)	<b>16 359 5140</b> (957298)	-	-	-		<b>16 363 0970</b> (581287)
50	Nrg Mc3 01-04	<b>16 359 2240</b> (581539)	<b>16 359 7030</b> (581173)	<b>16 359 5080</b> (560448)	-	-	-	<b>16 355 5690</b> (560711)	<b>16 363 0970</b> (581287)
50	Nrg Power Dd 06-09	<b>16 359 2240</b> (581539)	-	-	-	-	-	-	-
50	Nrg Power Dd Se- rie Spece 07-08	<b>16 359 2240</b> (581539)	-	-	-	-	-	-	-
50	Nrg Power Dt 06-08	<b>16 359 2240</b> (581539)	-	-	-	-	-	<b>16 355 5730</b> (564217)	-
50	Nrg Power Dt Serie Spec 07-08	<b>16 359 2240</b> (581539)	-	-	-	-	-	<b>16 355 5730</b> (564217)	-
50	Nrg Power Purejet 06-08	<b>16 359 2240</b> (581539)	-	-	-	-	-	-	-
50	Nrg Purejet 02-04	<b>16 359 2240</b> (581539)	-	<b>16 359 5080</b> (560448)	-	-	-	-	<b>16 363 0970</b> (581287)
50	Nrg Rst Mc2 96-98	<b>16 359 2280</b> (563902) Mod. 1998 Freno a Disco	<b>16 359 7030</b> (581173)	<b>16 359 5140</b> (957298)	-	-	-	<b>16 355 5070</b> (270993)	<b>16 363 0180</b> (563621)
50	Ntt 95-96	<b>16 359 2010</b> (270995)	<b>16 359 7010</b> (272290)	<b>16 359 5010</b> (272290)	-	-	-	<b>16 355 5070</b> (270993)	<b>16 363 0180</b> (563621)
50	Quartz 92-96	<b>16 359 2150</b> (268435)	<b>16 359 7020</b> (268402)	<b>16 359 5030</b> (268403)	-	-	-	<b>16 355 5310</b> (266213)	<b>16 363 0890</b> (268263)
50	Sfera 91-93	<b>16 359 2160</b> (267981) cavo 113mm Guaina 113mm	-	<b>16 359 5060</b> (267018) cavo mm40 guaina mm28	-	-	<b>16 355 0100</b> (268195)	<b>16 355 5310</b> (266213)	<b>16 363 0870</b> (266848)
50	Sfera Maquillage 2 94	-	<b>16 359 7140</b> (268811)	<b>16 359 5070</b> (268812) cavo mm53 guaina mm41	-	-	<b>16 355 0100</b> (268195)	<b>16 355 5310</b> (266213)	<b>16 363 0870</b> (266848)
50	Sfera Rst 95-97	<b>16 359 2150</b> (268435)	<b>16 359 7020</b> (268402)	<b>16 359 5080</b> (560448)	-	-	-	<b>16 355 5090</b> (562424)	<b>16 363 0880</b> (562403)
50	Typhoon 01-04	<b>16 359 2440</b> (957304)	<b>16 359 7300</b> (583334)	<b>16 359 5080</b> (560448)	-	-	-	<b>16 355 5070</b> (270993)	-
50	Vespa Et2 97-05	<b>16 359 2200</b> (581883)	<b>16 359 7170</b> (563227)	<b>16 359 5110</b> (562408)	-	-	-	<b>16 355 5090</b> (562424)	<b>16 363 1020</b> (56116R)
50	Vespa Et2 Iniezio- ne 97-00	<b>16 359 2200</b> (581883)	-	<b>16 359 5110</b> (562408)	-	-	-	<b>16 355 5090</b> (562424)	<b>16 363 1020</b> (56116R)
50	Vespa Et4 00-05	<b>16 359 2390</b> (582426)	-	-	-	-	-	<b>16 355 5730</b> (564217)	<b>16 363 1020</b> (56116R)
50	Vespa Lx 2T 05-08	-	-	-	-	-	-	<b>16 355 5090</b> (562424)	-
50	Vespa Lx 2T FI 09	-	-	-	-	-	-	<b>16 355 5090</b> (562424)	-
50	Vespa Lx 2T Touring 10	-	-	-	-	-	-	-	<b>16 363 1760</b> (649347)
50	Vespa Lx 4T 05-08	-	-	-	-	-	-	<b>16 355 5730</b> (564217)	-
50	Vespa Lx 4T-4V 09	-	-	-	-	-	-	<b>16 355 5730</b> (564217)	-
50	Vespa S 2T 07-08	-	-	-	-	-	-	<b>16 355 5090</b> (562424)	-
50	Vespa S 4T-4V 08-09	-	-	-	-	-	-	<b>16 355 5090</b> (562424)	-

Vedi pag. 313

Cc.	Modello - Models	GAS (Comando) Throttle Contr.	GAS (Sdopp. carb.) Doub carb.	GAS (Sdopp. mix) Doub Mixer	STARTER (Comando) Grip	STARTER (Sdopp. carb.) Doub. Carb.	FRENO ANT. Brake Front	FRENO POST. Brake Rear	CONTAKM. Speedom.
50	Zip 92-93	-	<b>16 359 7140</b> (268811)	<b>16 359 5070</b> (268812) cavo mm53 guaina mm41	-	-	<b>16 355 0110</b> (269657)	<b>16 355 5330</b> (569656)	<b>16 363 0190</b> (574331)
50	Zip 95-96	<b>16 359 2150</b> (268435)	<b>16 359 7020</b> (268402)	<b>16 359 5040</b> (271829)	-	-	<b>16 355 0110</b> (269657)	<b>16 355 5100</b> (271853)	<b>16 363 0190</b> (574331)
50	Zip 00-04	<b>16 359 2450</b> (561149)	<b>16 359 7300</b> (583334)	<b>16 359 5080</b> (560448)	-	-	-	<b>16 355 5360</b> (560781)	<b>16 363 1300</b> (581321)
50	Zip 2T 08-09	<b>16 359 2450</b> (561149)	<b>16 359 7300</b> (583334)	<b>16 359 5080</b> (560448)	-	-	-	-	<b>16 363 1300</b> (581321)
50	Zip 4T 00-08	-	-	-	-	-	-	<b>16 355 5840</b> (597141)	<b>16 363 1300</b> (581321)
50	Zip Bimodale 94-97	-	<b>16 359 7140</b> (268811)	<b>16 359 5070</b> (268812) cavo mm53 guaina mm41	-	-	<b>16 355 0110</b> (269657)	<b>16 355 5330</b> (569656)	<b>16 363 0190</b> (574331)
50	Zip Fast Raider 93-94	<b>16 359 2150</b> (268435)	<b>16 359 7020</b> (268402)	<b>16 359 5040</b> (271829)	-	-	-	<b>16 355 5100</b> (271853)	<b>16 363 0190</b> (574331)
50	Zip Fast Raider Rst 96-97	<b>16 359 2150</b> (268435)	<b>16 359 7020</b> (268402)	<b>16 359 5080</b> (560448)	-	-	-	<b>16 355 5360</b> (560781)	<b>16 363 0920</b> (581682)
50	Zip Rst 96-99	<b>16 359 2150</b> (268435)	<b>16 359 7020</b> (268402)	<b>16 359 5070</b> (268812) cavo mm53 guaina mm41	-	-	<b>16 355 0130</b> (560752)	<b>16 355 5360</b> (560781)	<b>16 363 0920</b> (581682)
50	Zip Sp 96-00	<b>16 359 2150</b> (268435)	<b>16 359 7020</b> (268402)	<b>16 359 5080</b> (560448)	-	-	-	<b>16 355 5360</b> (560781)	<b>16 363 0930</b> (582507)
50	Zip Sp 01-04	<b>16 359 2450</b> (561149)	-	<b>16 359 5080</b> (560448)	-	-	-	-	<b>16 363 0930</b> (582507)
50	Zip Sp Eu2 06-09	<b>16 359 2450</b> (561149)	-	<b>16 359 5080</b> (560448)	-	-	-	-	<b>16 363 0930</b> (582507)
80	Skr City 99	-	-	-	-	-	<b>16 355 0100</b> (268195)	-	<b>16 363 0870</b> (266848)
100	Fly 4T 06-09	-	-	-	-	-	-	-	<b>16 363 1650</b> (600315)
100	Free 02-03	<b>16 359 2140</b> (581132)	-	-	-	-	-	<b>16 355 5300</b> (597383)	-
100	Zip 4T 06-08	-	-	-	-	-	-	<b>16 355 5840</b> (597141)	<b>16 363 1300</b> (581321)
125	Beverly Eu3 07-08	-	-	-	-	-	-	-	<b>16 363 1620</b> (599866)
125	Beverly Eu3 Mic 07	-	-	-	-	-	-	-	<b>16 363 1620</b> (599866)
125	Beverly Eu3 Sport 07-08	-	-	-	-	-	-	-	<b>16 363 1620</b> (599866)
125	Beverly Rst 04-07	-	-	-	-	-	-	-	<b>16 363 1620</b> (599866)
125	Carnaby 07-09	-	-	-	-	-	-	-	<b>16 363 1780</b> (648929)
125	Fly 05-07	-	-	-	-	-	-	-	<b>16 363 1650</b> (600315)
125	Fly Eu3 07-08	-	-	-	-	-	-	-	<b>16 363 1650</b> (600315)
125	Hexagon 94-97	-	<b>16 359 7270</b> (271480)	-	-	-	-	<b>16 355 5700</b> (564107)	<b>16 363 0980</b> (274643)
125	Hexagon Gtx 00	<b>16 359 2360</b> (CM1065901)	-	-	-	-	-	-	<b>16 363 1090</b> (561279)
125	Hexagon Lx4 98-99	-	<b>16 359 7270</b> (271480)	-	-	-	-	<b>16 355 5700</b> (564107)	<b>16 363 1090</b> (561279)
125	Liberty 98	<b>16 359 0130</b> (561804)	-	-	-	-	-	<b>16 355 5740</b> (597320)	<b>16 363 0960</b> (560973)
125	Liberty 99-00	<b>16 359 2260</b> (563601)	-	-	-	-	-	<b>16 355 5740</b> (597320)	<b>16 363 0960</b> (560973)
125	Liberty 01-02	<b>16 359 2350</b> (CM065904)	-	-	-	-	-	<b>16 355 5730</b> (564217)	<b>16 363 0960</b> (560973)

Vedi pag. 314

Cc.	Modello - Models	GAS (Comando) Throttle Contr.	GAS (Sdopp. carb.) Doub carb.	GAS (Sdopp. mix) Doub Mixer	STARTER (Comando) Grip	STARTER (Sdopp. carb.) Doub. Carb.	FRENO ANT. Brake Front	FRENO POST. Brake Rear	CONTAKM. Speedom.
125	Liberty 4T 06-07	-	-	-	-	-	-	-	<b>16 363 1630</b> (600281)
125	Liberty 4T Eu3 07-08	-	-	-	-	-	-	-	<b>16 363 1630</b> (600281)
125	Liberty 4T Eu3 Delivery 08	-	-	-	-	-	-	-	<b>16 363 1630</b> (600281)
125	Liberty Rst 04-05	-	-	-	-	-	-	<b>16 355 5730</b> (564217)	<b>16 363 1630</b> (600281)
125	Liberty Rst Ptt 05-06	-	-	-	-	-	-	-	<b>16 363 1630</b> (600281)
125	Sfera 95-97	<b>16 359 0130</b> (561804)	-	-	-	-	-	-	<b>16 363 0880</b> (562403)
125	Skipper 94-97	<b>16 359 2150</b> (268435)	-	-	-	-	-	<b>16 355 5310</b> (266213)	<b>16 363 0890</b> (268263)
125	Skipper 4T 00-02	<b>16 359 0390</b> (CM065912)	-	-	-	-	-	<b>16 355 5750</b> (564474)	-
125	Skipper Lx 98-99	<b>16 359 2250</b> (564023)	-	<b>16 359 5160</b> (564052)	-	-	-	-	-
125	Super Hexagon Gtx 12 01-02	<b>16 359 2360</b> (CM1065901)	-	-	-	-	-	-	-
125	Vespa Et4 96-98	<b>16 359 0130</b> (561804) Mod fino al 08/98	-	-	-	-	-	<b>16 355 5090</b> (562424)	<b>16 363 1020</b> (56116R)
125	Vespa Et4 96-98	<b>16 359 2260</b> (563601) Mod. dal 09/98	-	-	-	-	-	<b>16 355 5090</b> (562424)	<b>16 363 1020</b> (56116R)
125	Vespa Et4 99-02	<b>16 359 0360</b> (CM065907)	-	-	-	-	-	<b>16 355 5730</b> (564217)	<b>16 363 1020</b> (56116R)
125	Vespa Granturi- simo 03-07	-	-	-	-	-	-	-	<b>16 363 1610</b> (599350)
125	Vespa Granturi- simo Eu3 06-07	-	-	-	-	-	-	-	<b>16 363 1610</b> (599350)
125	Vespa Gts Eu3 07-09	-	-	-	-	-	-	-	<b>16 363 1610</b> (599350)
125	Vespa Lx 05-06	-	-	-	-	-	-	<b>16 355 5730</b> (564217)	-
125	Vespa Lx 4T FI 09	-	-	-	-	-	-	<b>16 355 5730</b> (564217)	<b>16 363 1760</b> (649347)
125	Vespa Lx Eu3 06-08	-	-	-	-	-	-	<b>16 355 5730</b> (564217)	-
125	Vespa Lx Eu3 le 09	-	-	-	-	-	-	<b>16 355 5730</b> (564217)	<b>16 363 1760</b> (649347)
125	Vespa S 4T Eu3 07-08	-	-	-	-	-	-	<b>16 355 5730</b> (564217)	-
125	Vespa S 4T le 09	-	-	-	-	-	-	<b>16 355 5730</b> (564217)	-
125	X8 05-06	-	-	-	-	-	-	-	<b>16 363 1790</b> (648572)
125	X8 Premium Eu2 06	-	-	-	-	-	-	-	<b>16 363 1790</b> (648572)
125	X8 Premium Eu3 06-07	-	-	-	-	-	-	-	<b>16 363 1790</b> (648572)
125	X9 01-02	<b>16 359 0690</b> (CM065911)	-	-	-	-	-	-	-
125	X9 Evolution 03	<b>16 359 0690</b> (CM065911)	-	-	-	-	-	-	-
125	Zip 00-02	-	-	-	-	-	-	<b>16 355 5840</b> (597141)	<b>16 363 0930</b> (582507)
150	Fly 05-07	-	-	-	-	-	-	-	<b>16 363 1650</b> (600315)
150	Fly Eu3 08	-	-	-	-	-	-	-	<b>16 363 1650</b> (600315)
150	Liberty 01-02	<b>16 359 2350</b> (CM065904)	-	-	-	-	-	-	-

Vedi pag. 315

Cc.	Modello - Models	GAS (Comando) Throttle Contr.	GAS (Sdopp. carb.) Doub carb.	GAS (Sdopp. mix) Doub Mixer	STARTER (Comando) Grip	STARTER (Sdopp. carb.) Doub. Carb.	FRENO ANT. Brake Front	FRENO POST. Brake Rear	CONTAKM. Speedom.
250	X9 00-01	<b>16 359 0560</b> (581313) CHIUDE	-	-	-	-	-	-	-
250	X9 Evolution 04	<b>16 359 0690</b> (CM065911)	-	-	-	-	-	-	-
400	Beverly Eu3 06-07	<b>16 359 2410</b> (598618) CHIUDE	-	-	-	-	-	-	<b>16 363 1770</b> (599685)
400	Beverly Tourer Eu3 08-09	-	-	-	-	-	-	-	<b>16 363 1770</b> (599685)
400	X Evo 07-09	<b>16 359 2410</b> (598618) CHIUDE	-	-	-	-	-	-	-
400	X8 Eu3 06-08	-	-	-	-	-	-	-	<b>16 363 1790</b> (648572)
500	Beverly 02-04	<b>16 359 2400</b> (598617) APRE	-	-	-	-	-	-	<b>16 363 1770</b> (599685)
500	Beverly 02-04	<b>16 359 2410</b> (598618) CHIUDE	-	-	-	-	-	-	<b>16 363 1770</b> (599685)
500	Beverly 05-06	<b>16 359 2400</b> (598617) APRE	-	-	-	-	-	-	<b>16 363 1770</b> (599685)
500	Beverly 05-06	<b>16 359 2410</b> (598618) CHIUDE	-	-	-	-	-	-	<b>16 363 1770</b> (599685)
500	Beverly Eu3 06-08	<b>16 359 2400</b> (598617) APRE	-	-	-	-	-	-	<b>16 363 1770</b> (599685)
500	Beverly Eu3 06-08	<b>16 359 2410</b> (598618) CHIUDE	-	-	-	-	-	-	<b>16 363 1770</b> (599685)
<b>SCOOTER CINESI</b>									
50	GY6								<b>16 363 2030</b>
<b>SUZUKI</b>									
50	Ay A K5-K6 05-06	-	-	-	-	-	-	-	<b>16 363 1160</b> (34910-35E00-000)
50	Ay A'Yw Katana V-Y 97-00	-	-	-	-	-	-	-	<b>16 363 1160</b> (34910-35E00-000)
50	Ay Ayw K1-K4 01-04	-	-	-	-	-	-	-	<b>16 363 1160</b> (34910-35E00-000)
250	Burgman W-K2 98-02	<b>16 359 0220</b> (58300-4F00-000) APRE	-	-	-	-	-	<b>16 355 5610</b> (58810-14F00-000)	-
400	Burgman X-K2 99-02	-	-	-	-	-	-	<b>16 355 5610</b> (58810-14F00-000)	-
<b>SYM</b>									
50	Dd 02	-	-	-	-	-	-	-	<b>16 363 1810</b> (44830T47000)
50	Dd Eu2 03-07	-	-	-	-	-	-	-	<b>16 363 1810</b> (44830T47000)
50	Jet 99-01	-	-	-	-	-	-	-	<b>16 363 1840</b> (486232E+308)
50	Jet Euro X Eu2 03-07	-	-	-	-	-	-	-	<b>16 363 1840</b> (486232E+308)
50	Jet4 09-10	-	-	-	-	-	-	-	<b>16 363 1880</b> (44830ABA000)
50	Mio 06-09	-	-	-	-	-	-	-	<b>16 363 1810</b> (44830T47000)
50	Mio Eu3 07-08	-	-	-	-	-	-	-	<b>16 363 1810</b> (44830T47000)
50	Red Devil 99	-	-	-	-	-	-	-	<b>16 363 1840</b> (486232E+308)

Vedi pag. 316

## TRASM. CONTAKM. VESPA-LAMBRETTA



Cilindrata	Modello	Cod. RMS	Codice a barre	Cod. Originale
50	Ciao	16 355 0990		187423
50	N- R- Special	16 363 1010		071059
50	Pk	16 363 1040		195407
50	Hp	16 363 1030		266231
90	Ss-Sprinter	16 363 1010		071059
125	Primavera	16 363 1010		071059
125	Primavera att/ rapido	16 363 1960		183582
125	Et3	16 363 1010		071059
125	Pk	16 363 1040		195407
125	Fl2	16 363 1030		266231
125	Vespa Px	16 363 1830		
150	Sprint	16 363 1900		099011
150	Gl 64	16 363 1910		097713
150	65	16 363 1920		098641
150	59	16 363 1930		
160	Gs	16 363 1940		057045
180	Ss	16 363 1950		090525
200	Rally	16 363 1950		090525
125-150 200	Px 1 serie	16 363 1050		176160
125-150 200	Px arcobaleno	16 363 1060		179271
125-150 200	Px freno a disco	16 363 1250		563796
125-150 200	Cosa 1-2	16 363 1070		229358
125-150 200	Lambretta Li terza serie	16 363 1970		00611068
125-150 200	Lambretta DL	16 363 1980		00611125

Vedi pag. 321

<b>Marca modello</b> <b>Trademark model</b>	<b>Codice</b> <b>Code</b>
--	------------------------------

**PIAGGIO:** Zip Sp 50  
(R.O. 56072R)

**20 458 4230**



- Amm. Anteriore
- Attacco sup. a perno
- Corpo nero
- Molla colore gialla
- Interasse mm 220
- Made in Italy

- Front shock absorber
- Upper connection pin
- Body black
- Spring colour yellow
- lenght mm 220
- Made in Italy



Vedi pag. 420

**22 510 0310**

**22 510 0311**

**22 510 0312**

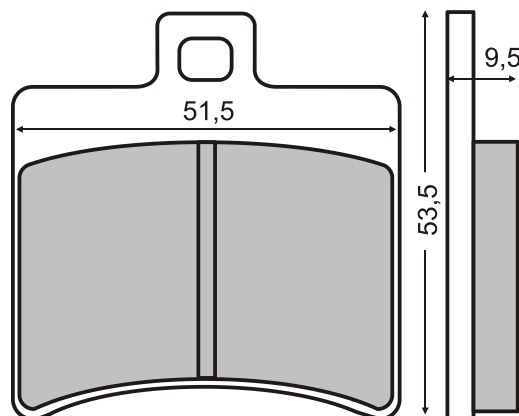

Vedi pag. 449

**KYMCO**

**10 008 0160** 

**Raff. Liquido - Liquid Cooled Ø 72,7 mm**  
250: B&W 00 • B&W Eu2 03 • Grand Dink 01-02  
• Grand Dink Eu2 03-04 • People Lc 03-04 •  
~~People S 250-06-07~~ • ~~X Ciring 05~~ • Yup 03



Vedi pag. 25

**10 060 0780** 

250: Sv 01-02  
(R.O. 754906)



Vedi pag. 128

**18 416 0500** 

Colore: Grigio / Nera - Colour: Grey / Black  
Manopole bicolore in gomma termoplastica  
Two - colour grips in rubber compound  
Lunghezza - Length 125 mm



**18 416 0510** 

Colore: Nera / Rossa - Colour: Black / Red



**18 416 0520** 

Colore: Nera / Grigia - Colour: Black / Grey



Vedi pag. 296

Marca modello Trademark model	Codice Code	Marca modello Trademark model	Codice Code	Marca modello Trademark model	Codice Code
	<b>20 458 4290</b> 		<b>20 458 4300</b> 		<b>20 458 4310</b> 

**PIAGGIO:**

Vespa Px  
125-150-200  
Ammortizzatore  
idraulico  
Stelo  
pompano Ø 14

Ammortizzatore  
anteriore  
Attacco superiore a  
perno  
Corpo rosso  
Molla bianca  
Interasse mm 282  
~~Stelo pompano mm 14~~  
Made in Italy

Front shock absorber  
Upper connection pin  
Shock body red  
Spring colour white  
length mm 282  
Pump stem mm 14  
Made in Italy



**PIAGGIO:**

Vespa PK 50 XL Rush-N-  
FL-HP-PK 125-PK 125 XL  
Ammortizzatore idraulico  
~~con Stelo  
pompano Ø 11~~

Ammortizzatore  
anteriore  
Attacco superiore a  
perno  
Corpo rosso  
Molla bianca  
Interasse mm  
Stelo pompano mm 11  
Made in Italy

Front shock absorber  
Upper connection pin  
Shock body red  
Spring colour white  
length mm  
pump stem mm 11  
Made in Italy



**PIAGGIO:**

Vespa Px  
125-150-200  
Ammortizzatore rego-  
labile  
~~Stelo  
pompano Ø 14~~

Ammortizzatore ante-  
riore  
Attacco superiore a  
perno  
Corpo rosso  
Molla bianca  
Interasse  
Regolabile  
Stelo pompano mm 14  
Made in Italy

Front shock absorber  
Upper connection pin  
Shock body red  
Spring colour white  
Length  
Adjustable  
Pump stem mm 14  
Made in Italy



Vedi pag. 424

**Marca modello**  
*Trademark model*

**Codice**  
*Code*

**20 455 0290**



**PIAGGIO:**

Vespa 50 Special 125 Et3 Primav. Px 125-150-200

Ammortizzatore idraulico

~~Stelo pompante Ø 11~~

Precarico molla regolabile

Ammortizzatore posteriore completo

Attacco superiore a perno

Attacco inferiore a forcella mm 48

Corpo rosso

Molla bianca

Interasse

Stelo pompante mm 11

Regolabile

Made in Italy

Rear shock absorber

Upper connection pin

Lower connection fork mm 48

Shock body red

Spring colour white

Lenght

pump stem mm 11

Adjustable

Made in Italy



**Marca modello**  
*Trademark model*

**Codice**  
*Code*

**20 455 0380**



**PIAGGIO:**

Vespa Pk 50 - XL Rush-N-FL-HP-Pk 125-k 125 XL

Ammortizzatore idraulico

~~Stelo pompante Ø 11~~

Ammortizzatore posteriore completo

Attacco superiore a perno

Attacco inferiore a forcella mm 42

Corpo rosso

Molla bianca

Interasse

Stelo pompante mm 11

Regolabile

Made in Italy

Rear shock absorber

Upper connection pin

Lower connection fork mm 42

Shock body red

Spring colour white

Lenght

pump stem mm 11

Adjustable

Made in Italy



**Marca modello**  
*Trademark model*

**Codice**  
*Code*

**20 455 0410**



**PIAGGIO:**

Vespa Px 125-150-200 con freno a disco

~~Corpo rosso molla bianca (con distanziale)~~

Ammortizzatore posteriore completo

Attacco superiore a perno

Attacco inferiore a forcella mm 48

Corpo rosso

Molla bianca

Interasse

Regolabile

Con distanziale

Made in Italy

Rear shock absorber

Upper connection pin

Lower connection fork mm 48

Shock body red

Spring colour white

Lenght

Adjustable

With spacer

Made in Italy



**Marca modello**  
*Trademark model*

**Codice**  
*Code*

**20 455 0420**



**PIAGGIO:**

Vespa Gtv-Gts 125-250-300

~~Corpo e molla bianco perlato~~

Ammortizzatore posteriore completo

Attacco superiore a perno

Attacco inferiore a forcella

Corpo bianco

Molla bianca

Interasse

Regolabile

Made in Italy

Rear shock absorber

Upper connection pin

Lower connection fork

Shock body white

Spring colour white

Lenght

Adjustable

Made in Italy



Vedi pag. 425

**24 617 0010** 

**PICK-UP 50 cc**

**GILERA:** Stalker - Runner  
Typhoon - X - Xr - Dna

**PIAGGIO:**

Sfera Maquillage 2-Rst - Base - Liberty  
Et2 - Quartz-Zip Base - Rst-Fast Rider - Sp  
Free - Ntt-Nrg - Rst - Mc2  
Extreme-Skr City 80 - (R.O. 498865)



Vedi pag. 681

**24 617 0020** 

**PICK-UP PIAGGIO**

**Ape 50:** Tmp 85/89-FL/FL2 89/95  
FL Europa 96/99-Rst Mix99/05  
Vespa 50-Pk XL 85/88-Rush 88/89  
N 89/90-FL2 Hp 91/97  
FL 90-Pk 50/125 82/84  
125 Pk XL 86/89  
<FL 89/90  
Px T5 85/89  
125-150-200 Px 98/01  
Pxe Arcobaleno 81/97  
Cosa CL-CLX 88/91  
Cosa 2 91/97  
(R.O.196549)



**24 617 0030** 

**PICK-UP 50 cc**

**MBK:** Booster 90>-Road-Spirit-Spirit kat-  
Sorriso-Ovetto-Evolis-Target-Fizz-Forte  
Nitro-Nitro F1-Flipper

**YAMAHA:** Aerox-Aerox R-Aerox R kat  
Why-Why kat - Axis-Bw's Original  
Original kat-Neo's-Crz-Ctss-Breeze



**12 187 0500** 

**Kit Minuteria Revisione Pignone Avviam.**

Vespa 50 Pk - FL - FL2 Automatica - FL2 Hp - N  
Pk Automatica - Pk XL Plurimatic - Rush - Pk XL  
Vespa 125 FL - Pk XL  
(R.O. 249482)



Vedi pag. 695

**24 635 0030** 

**Anello Portaspazzole**

Vespa Pk 50 - Ape 50  
(R.O. 179755-291383)

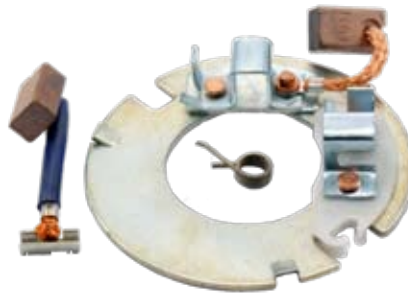

**24 649 0130** 

**PRESA BASSA TENSIONE - L.T. SOCKET ASSY**

**PIAGGIO:** Vespa 125-150 Px  
(R.O. 179895)

**FOTO NUOVA**



Vedi pag. 581

~~**24 256 0140** ~~

~~**PORTA OGGETTI - OBJECTS CONTAINER**~~

~~**PIAGGIO:** Vespa 125-150 Px • T5  
(R.O. 233112)~~



~~Vedi pag. 579~~